

**ebm-papst St. Georgen GmbH & Co. KG**

Hermann-Papst-Str. 1  
 D-78112 St. Georgen  
 Phone +49 (0) 7724 81-0  
 Fax +49 (0) 7724 81-1309  
 info2@de.ebmpapst.com  
 www.ebmpapst.com

**Nominal data**

Type	412 F	
Nominal voltage	VDC	12
Nominal voltage range	VDC	10 .. 14
Speed	min <sup>-1</sup>	5400
Power input	W	0.7
Min. ambient temperature	°C	-20
Max. ambient temperature	°C	70
Air flow	m <sup>3</sup> /h	8
Sound power level	B	4.4
Sound pressure level	dB(A)	22.1

ml = Max. load · me = Max. efficiency · fa = Running at free air · cs = Customer specs · cu = Customer unit  
 Subject to alterations

**Technical features**

<b>Mass</b>	0.017 kg
<b>Dimensions</b>	40 x 40 x 10 mm
<b>Material of impeller</b>	Fiberglass-reinforced PA plastic
<b>Housing material</b>	Fiberglass-reinforced PBT plastic
<b>Direction of air flow</b>	Air exhaust over bars
<b>Direction of rotation</b>	Left, looking at rotor
<b>Bearing</b>	Sintec sleeve bearing system
<b>Lifetime L10 at 20 °C</b>	45000 h
<b>Lifetime L10 at 60 °C</b>	17500 h
<b>Connection line</b>	Single strands AWG 28, TR 64, bared and tin-plated.
<b>Motor protection</b>	Protected against reverse polarity and locking.
<b>Approval</b>	VDE, CSA, UL
<b>Option</b>	Special options: Speed signal Go / No-go alarm Moisture protection



## Product drawing

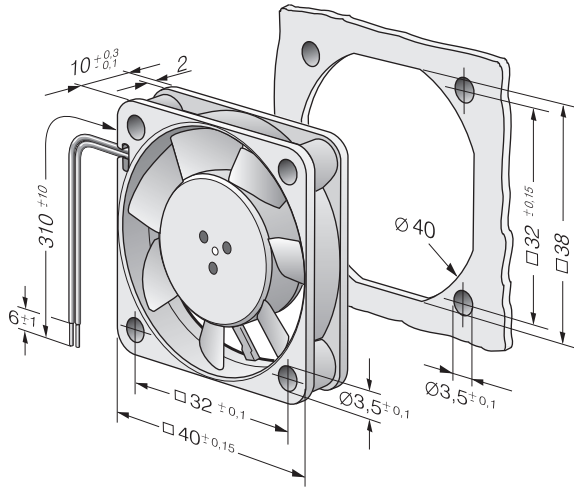

## Charts: Air flow

